



National Institutes for
Quantum Science and Technology

QST

National Institutes for
Quantum
Science and
Technology

Success will come where there is hope.



National Institutes for
Quantum Science and Technology

President

KOYASU Shigeo



The National Institutes for Quantum Science and Technology (QST) is committed to creating and providing new value through research and development related to quantum science and technology, thereby contributing to the realization of a sustainable future society in which the economy, society, and environment are in harmony.

QST is unique in that it promotes a wide range of research and development, from energy development to life science and medicine, based on quantum science and technology, and has a variety of large-scale R&D facilities and equipment, including quantum beam facilities, fusion energy facilities, and a research hospital. QST's world-class large-scale R&D facilities and equipment are widely used not only for R&D within QST but also by universities and other institutions, contributing to the "maximization of research achievements" required of a National Research and Development Agency.

QST is designated as a Foundational Quantum Technology Hub and a Quantum Life R&D Hub among the national Quantum Technology Innovation Hubs and promotes research and development of quantum materials, which are key materials for quantum devices, and the use of quantum life technology, which links quantum technology with life science and medicine. In addition, we have been designated as a Fusion Technology Innovation Hub under the Fusion Energy Innovation Strategy and are conducting research and development toward the realization of fusion energy generation under the slogan "Creating a sun on Earth!" In the field of life science and medicine, we aim to contribute to the realization of a healthy and longevity society through heavy-ion cancer radiotherapy, targeted radionuclide therapy, and imaging technology for the diagnosis of dementia and other diseases. Furthermore, QST has been designated as the Core Advanced Radiation Emergency Medical Support Center and is engaged in technical development and human resource training related to radiation exposure medicine and radiation effects. The 3 GeV Synchrotron Radiation Facility, NanoTerasu, which was developed and installed by utilizing the quantum beam generation technology cultivated thus far, will begin creating innovative materials and devices and applying them to industry in April 2024.

The second medium- to long-term period of QST began in April 2023. By further upgrading the world's most advanced and high-performance large-scale R&D facilities and their basic technologies that have been established to date, QST aims to promote innovative research and development through collaborative creation and facility sharing between ourselves and researchers in Japan and overseas, and to lead the world not only in quantum science and technology but also in a wide range of other fields.

Contents

National Institutes for Quantum Science and Technology

- 3-4 Research and Development for Creating the Future
- 5-6 QST research institutes and main quantum science and technology platform facilities and equipment
- 7-8 Quantum Technology Innovation Research Area (Foundational quantum technology research)
- 9-10 Quantum Technology Innovation Research Area (Quantum life science research)
- 11-14 Quantum Medical Science Area
- 15-18 Quantum Energy Science and Technology Area
- 19-20 Quantum Beam Science Area
- 21 Promotion of practical application of research results through industry-academia collaboration
- 22 Diversity activities

QUANTUM INNOVATION

Utilizing our quantum science and technology platform consisting of a variety of world-class, large-scale research and development facilities and equipment, we are conducting a wide range of research and development, from energy development to life science and medicine, centered on quantum science and technology.

Through these research and development efforts, we aim to contribute to Japan's economic growth through a productivity revolution and the creation of new industries, a healthy and longevity society by overcoming cancer and dementia, and a green transformation through carbon neutrality and a circular economy, thereby creating a sustainable future society in which the economy, society, and environment are in harmony.

Research and development for creating the future

- QST promotes advanced and creative research and development in four research areas based on our quantum science and technology platform: quantum technology innovation research, quantum medical science, quantum energy research, and quantum beam science.
- By utilizing the world's most advanced and high-performance large-scale research and development facilities and their fundamental technologies, QST contributes to "maximizing research achievements" through collaborative creation and facility sharing between ourselves and domestic and overseas researchers, and leads the world not only in quantum science and technology but also in a wide range of other fields.
- QST plays a core function in various national strategies, and engages in research and development, human resource development, etc.

R&D Hubs designated by the government

Foundational Quantum Technology Hub
[Vision of Quantum Future Society/Strategy of Quantum Future Industry Development]



Quantum Materials and Applications Research Center Building (scheduled for completion in 2026)

Quantum Life R&D Hub
[Quantum Technology Innovation Strategy]



Quantum Life Science Research Building

Radiation Emergency Medicine Hub
[Designated as Core Advanced Radiation Emergency Medical Support Center by the Nuclear Regulatory Commission]



Dose Assessment Building for Advanced Radiation Emergency Medicine

Fusion Technology Innovation Hub
[Fusion Energy Innovation Strategy]



Blanket Test Facility Building

3 GeV Synchrotron Radiation Facility, NanoTerasu
[The specific advanced large research facility (operation start in FY2024)]



View of NanoTerasu

Realization of a Sustainable Future Society through Quantum Science and Technology Research, etc.

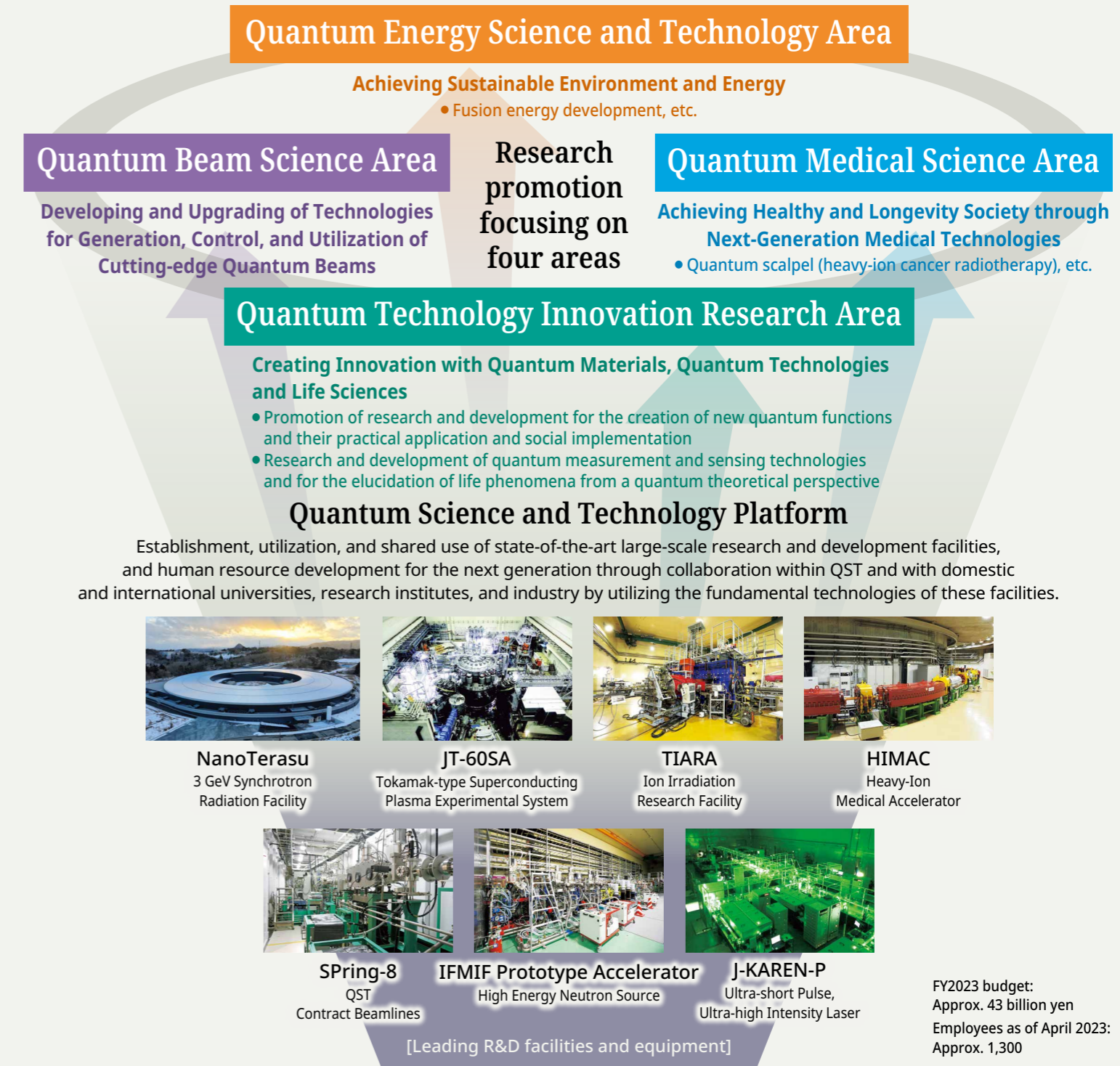

QST RESEARCH INSTITUTES

QST research institutes and leading quantum science and technology platform facilities and equipment

Takasaki Institute for Advanced Quantum Science



Ion Irradiation Research Facility
TIARA (in service)



Electron-beam
Irradiation Facility
(in service)



Cobalt 60 Gamma-ray irradiation
Facilities (in service)

Kansai Institute for Photon Science (Kizu site)



Laser Experiment Facility
J-KAREN-P (in service)



QUADRA-T (in service)

Kansai Institute for Photon Science (Harima site)



QST contract Beamlines at Large Synchrotron Radiation Facility Spring-8
BL11XU (in service)



BL14B1 (in service)

Rokkasho Fusion Institute



International Fusion Materials
Irradiation Facility (IFMIF)
Prototype Accelerator (under development)

Headquarters

4-9-1 Anagawa, Inage-ku, Chiba-shi, Chiba 263-8555; Tel. +81-43-382-8001

Institute for Quantum Life Science, Institute for Quantum Medical Science, QST Hospital,
Institute for Radiological Science

4-9-1 Anagawa, Inage-ku, Chiba-shi, Chiba 263-8555; Tel. +81-43-251-2111

Takasaki Institute for Advanced Quantum Science

1233 Watanukimachi, Takasaki-shi, Gunma 370-1292; Tel. +81-27-346-9232

Kansai Institute for Photon Science (Kizu), The Kids' Science Museum of Photons
8-1-7 Umemidai, Kizugawa-shi, Kyoto 619-0215; Tel. 0774-71-3000

Kansai Institute for Photon Science (Harima)

1-1-1 Kouto, Sayo-cho, Sayo-gun, Hyogo 679-5148; Tel. +81-791-58-2111

Institute for Advanced Synchrotron Light Source

6-6-11-901 Aza Aoba, Aramaki, Aoba-ku, Sendai, Miyagi 980-8579; Tel. +81-22-785-9480

Naka Fusion Institute

801-1 Mukoyama, Naka-shi, Ibaraki 311-0193; Tel. +81-29-270-7213

Rokkasho Fusion Institute

2-166, Oaza-Obuchi-Aza-Omotodate, Rokkasho-mura, Kamikita-gun, Aomori 039-3212; Tel. +81-175-71-6500

Tokyo Office

22nd floor, Fukoku Seimei Building, 2-2-2 Uchisaiwaicho, Chiyoda-ku, Tokyo 100-0011; Tel. +81-3-6852-8165

Institute for Advanced Synchrotron Light Source



3 GeV Synchrotron Radiation Facility
NanoTerasu (for sharing according to the Act on the Promotion of Public
Utilization of the Specific Advanced Large Research Facilities)

Naka Fusion Institute

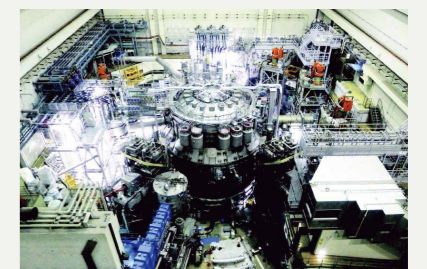

Tokamak-type Superconducting
Plasma Experimental System JT-60SA



Institute for Quantum Life Science



Quantum Life Science Research
Building

Institute for Quantum Medical Science



Heavy-Ion Cancer Radiotherapy Facility
HIMAC (in service)

QST Hospital



QST Hospital

Institute for Radiological Science



Advanced Radiation Medical
Dosimetry Building

Mission

Ultra-smart society developed by quantum technologies

Foundational quantum technology research aims to establish technologies for quantum computing, quantum communication, quantum sensing, etc., and conducts research and development of quantum materials and devices that are indispensable for these technologies, establishing foundational quantum technologies and promoting research and development for the creation of new quantum functions through integration with state-of-the-art optical technologies. We will also build a stable supply base of the world's most advanced quantum materials and promote their practical application and social implementation in a wide range of fields.

Core institutes ▶ Takasaki Institute for Advanced Quantum Science, Kansai Institute for Photon Science

Related institutes ▶ Institute for Advanced Synchrotron Light Source, Institute for Quantum Life Science

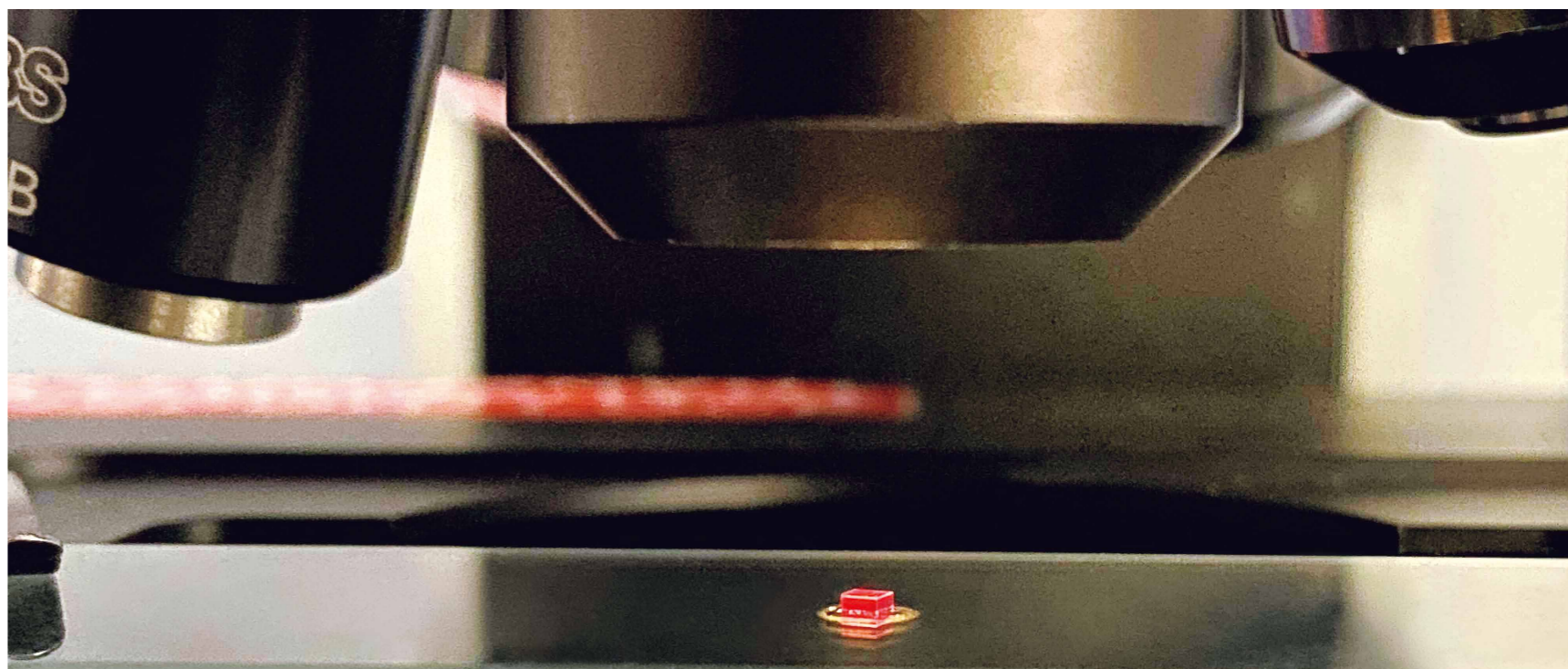

Foundational Quantum Technology Hub

We are engaged in pioneering research and development of quantum materials and devices that exhibit advanced quantum functions, and in the establishment of a stable supply base for such materials and devices, utilizing our strengths in various quantum beam facilities such as ion beams, electron beams, lasers, and synchrotron radiation, and in advanced quantum beam technologies. Based on the quantum material and device technologies developed here, we will promote the development and industrial application of quantum computing, quantum sensing, quantum communication, and information devices, and link them to the realization of a future society that harmonizes economy, society, and environment, known as Society 5.0.

Quantum Technology

Quantum technology is a technology that makes use of the behavior of quantum particles, which are ultra-small particles in the microscopic world of atoms and electrons. Quantum technology is expected to be applied to quantum computers, highly sensitive quantum measurement and sensing, and high-security quantum networks, and to be developed in various fields such as medicine, materials manufacturing, finance, energy, and transportation.

Unique technology

"High-density" single photon source



We will promote the exploration and creation of quantum materials such as single-photon sources using advanced quantum beam technology, as well as research and development of advanced quantum state measurement and control technology integrated with optical technologies.



Laser-cooled ion trap



Photon-spin interconversion control

Quantum technology using unique technology

Quantum computers and quantum internet



Aiming for applications in a wide range of medical and industrial fields, we will promote the creation and promotion of quantum computers, quantum sensors, quantum communication and information devices, etc., based on our unique quantum material technologies



Quantum sensors and measurement

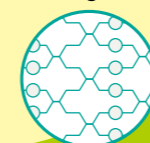

Quantum circuits and quantum memory

Future society pioneered by quantum technology

Staying healthy until age 100 with constant health monitoring and proper care

Automated driving to relieve traffic congestion and eliminate traffic accidents

Realization of Society 5.0

Realizing safe and comfortable living in a smart house

Sustainable economic growth through productivity revolution and smartification

Creation of quantum materials and devices and establishment of supply base

Using advanced quantum beam technology, we will develop technologies for the creation of solid-state spin qubits such as diamond NV centers, quantum materials that can be used as single-photon sources, and quantum devices such as quantum sensors and quantum repeaters using these materials. Furthermore, we will promote the utilization and practical application of quantum technology in industry, academia, and government by providing a stable supply of high-quality, high-performance quantum materials and devices and developing an environment for their use.

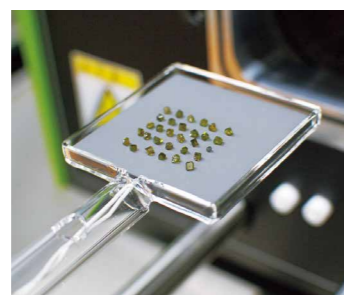

Diamond NV center is fabricated by electron irradiation and heat treatment.

Development of cutting-edge laser technology and its integration with quantum material and device technology

We will promote the combination of optical technologies such as ultra-short pulse lasers with quantum material and device technologies, and carry out research and development of ultra-short pulse lasers and quantum state measurement and control technologies, aiming to realize ultra-fast and low-loss spin-photon devices by optical control. In ultra-fast dynamics research, which is important in the manipulation of quantum functions by light, we use theory and simulation techniques to understand ultra-fast phenomena and clarify their physical mechanisms, and apply this knowledge to the creation of innovative quantum materials and devices and to the academic exploration of quantum life science.



Ultra-short pulse laser equipment

Development and securing of quantum technology human resources for the next generation

In order to realize seamless social implementation of quantum technology developed at the hubs, we will welcome researchers and engineers from industry, academia, and government, and contribute to the development and securing of human resources in quantum technology who will play a key role in pioneering future quantum technology fields and strengthening international competitiveness through training and practice utilizing test beds established in the industry-academia collaborative open laboratory and participation in research, development and industrial application of quantum materials and devices.



Quantum Materials and Applications Research Center Building (scheduled for completion in 2026)

Mission

Challenge the question "What is life?" with Quantum eyes and hands

Quantum life science research promotes research and development to utilize quantum measurement technology and elucidate life phenomena from a quantum theoretical viewpoint. In addition to promoting applied research in the fields of medicine and drug discovery, we will develop a new academic field that will lead to the elucidation of the ultimate question for mankind, "What is life?"

Core institutes ▶ Institute for Quantum Life Science

Related institutes ▶ Institute for Advanced Synchrotron Light Source, Takasaki Institute for Advanced Quantum Science, Kansai Institute for Photon Science, Institute for Quantum MedicalScience, Institute for Radiological Science

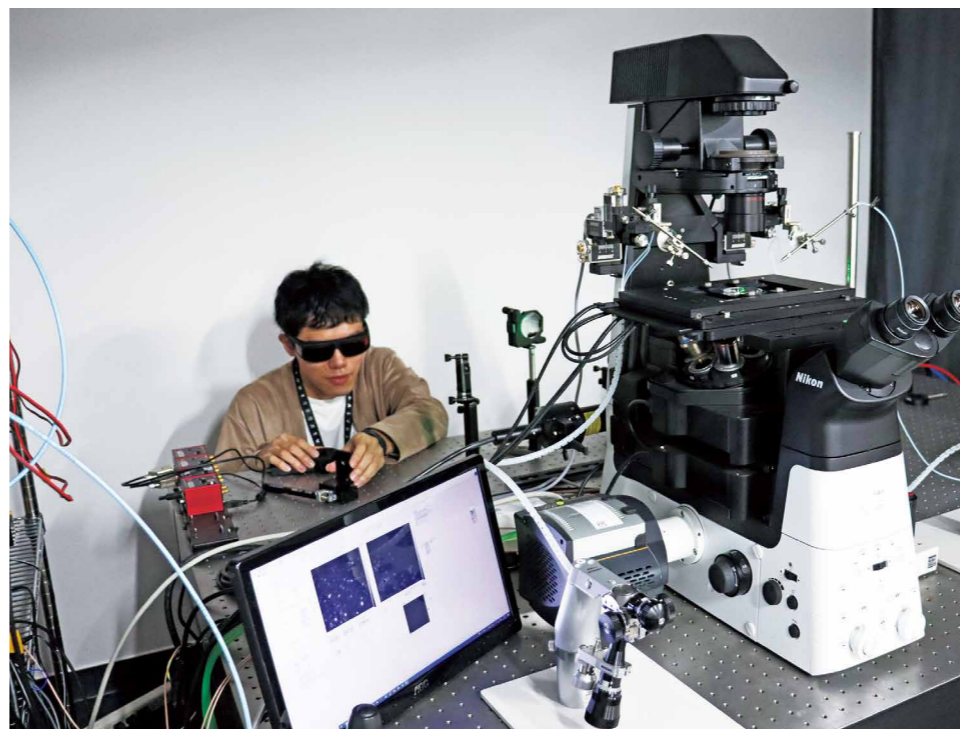

Quantum Life R&D Hub

Extending life science from the conventional molecular level to the quantum level, understanding and integrating its hierarchical system.

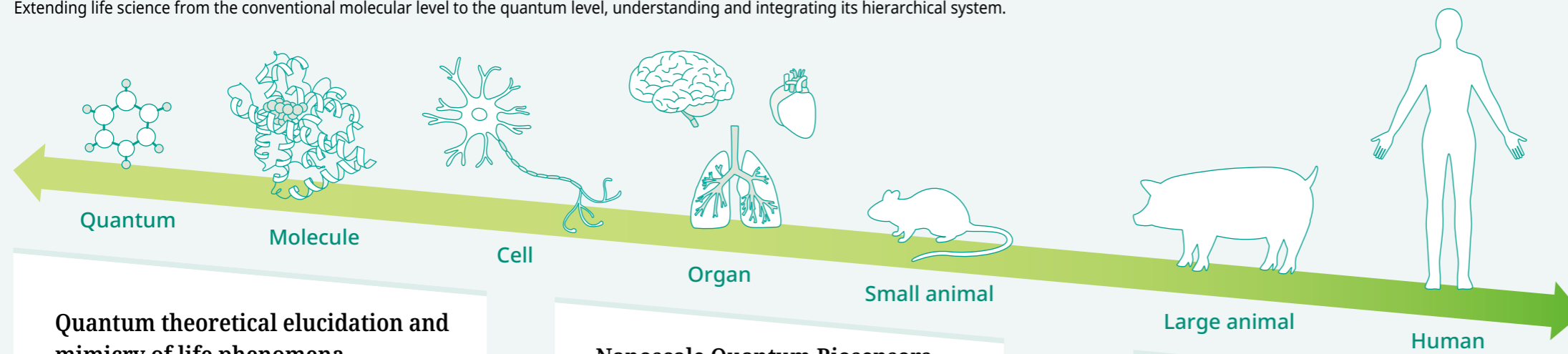

Quantum theoretical elucidation and mimicry of life phenomena

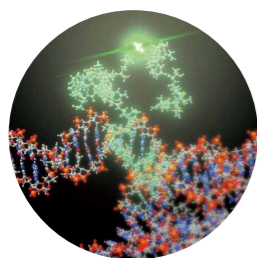

Collaboration

Understanding the mechanisms of biomolecular function expression

We will analyze quantum effects in photosynthesis, magnetoreception, and other biological processes by developing quantum coherence measurement technology, analyze the quantum level structure of biomolecules, contribute to drug discovery and bioproduction by applying the functions of biomolecules, and promote research and development toward biomimetics.

Nanoscale Quantum Biosensors

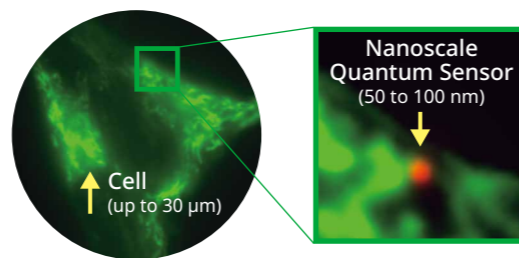

Detection of abnormality in cells using nanoscale quantum sensors

Through real-time and precise measurements of temperature and pH inside living cells by quanta (NV centers) in nano-sized diamond crystals, we will work to elucidate complex biological phenomena such as immunology, regenerative medicine, cranial nerves, and cancer.

Collaboration

Ultra-high sensitivity MRI/NMR using quantum technology

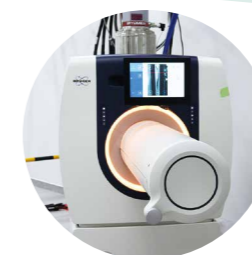

Realization of ultra-sensitive MRI by aligning nuclear spins

By realizing "hyperpolarization technology" that enhances MRI signals emitted by drugs by more than 10,000 times, we will track, as images, changes in metabolism (physiological chemical changes) that occur in the body due to cancer, dementia, and other diseases, and promote research and development for ultra-early diagnosis.



As a Quantum Life R&D Hub open to a wide range of companies, universities, and external research institutions, industry, academia, and government will work together in a unified manner to conduct everything from basic research to technology demonstration, open innovation, intellectual property management, and human resource development.



Institute for Quantum Life Science, the center of research activities. It combines experimental facilities for state-of-the-art quantum measurement and sensing technology with those for life sciences.

Mission

Healthy and longevity society with zero cancer deaths and zero dementia

In order to realize a healthy and longevity society, we will promote research and development toward the standardization of heavy-ion cancer radiotherapy and social implementation of the next-generation heavy-ion cancer radiotherapy system "quantum scalpel", as well as research and development of diagnostic and therapeutic technologies for neuropsychiatric diseases, solid tumors, multiple and micro cancers, etc. We will promote research and development from basic to clinical research and actual medical treatment by utilizing the strengths of the QST Hospital in addition to our knowledge of quantum life science and radiation effects research.

Core institutes ▶ Institute for Quantum Medical Science, QST Hospital

Related institutes ▶ Institute for Quantum Life Science, Institute for Radiological Science, Takasaki Institute for Advanced Quantum Science, Kansai Institute for Photon Science



Heavy-ion cancer radiotherapy research

With the aim of expanding insurance coverage of heavy-ion cancer radiotherapy and establishing it as a standard treatment for cancer, we will promote clinical and translational research, including combinatorial therapies effective in improving treatment efficacy, and lead joint clinical research with other treatment facilities.



QST Hospital

Development of next-generation heavy-ion cancer radiotherapy system

In addition to research and development of a compact next-generation heavy-ion cancer radiotherapy system (Quantum Scalpel) and its social implementation, we will promote research and development of high-precision treatment technologies such as multi-ion irradiation, which combines beams of multiple ion species according to the nature of the tumor to enhance the therapeutic effect.

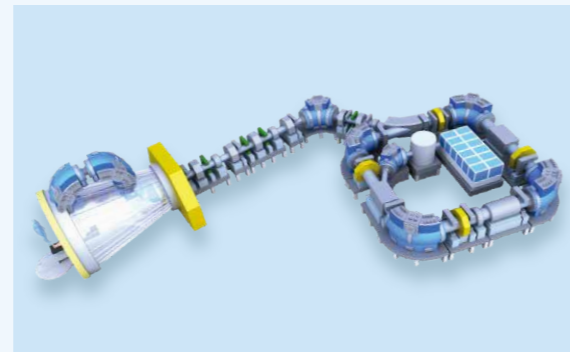

Quantum Scalpel (image)

Diagnostic and therapeutic research on neuropsychiatric disorders

We conduct research and development of technologies for high-accuracy diagnosis and objective assessments of neuropsychiatric disorders represented by dementia and depression. Based on these accomplishments, we promote the drug development to suppress the disease onset and progression and the manipulation of neural circuits for understanding brain functions toward therapeutic controls.

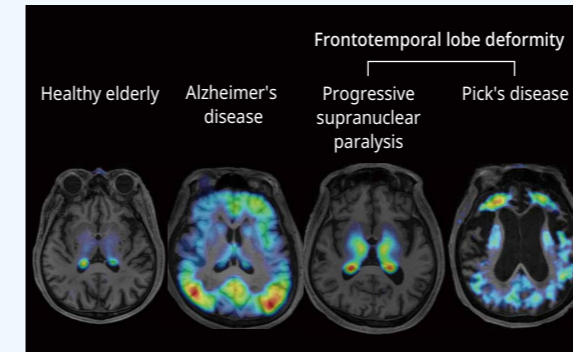

Early detection and differentiation of various types of dementia using technology to visualize tau lesions

Research on radiopharmaceutical cancer diagnosis and treatment

Using the innovative medical technology of "theranostics" (combination of treatment and diagnosis) utilizing radiopharmaceuticals, we will promote targeted radioisotope therapy (TRT) research, develop radiopharmaceuticals that are effective against multiple and micro cancers, as well as promoting clinical research.

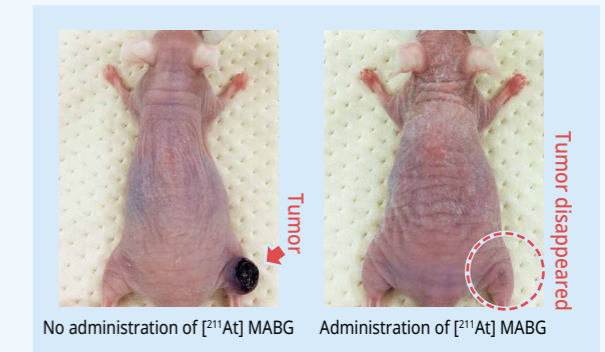

TRT for model mouse with malignant pheochromocytoma



New Particle Therapy Research Facilities



Multi-ion source for more advanced treatment

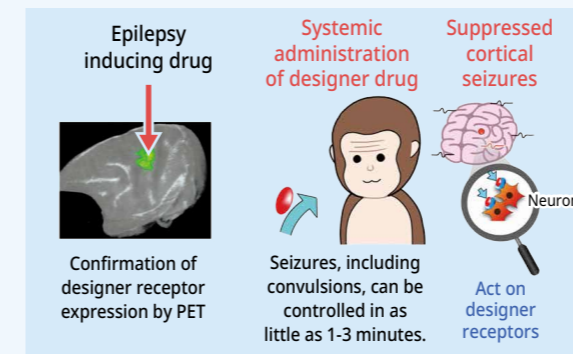

On-demand treatment of epilepsy by manipulation of neural circuits



World's first mobile TRT treatment facility

Mission

Social system to protect the public from radiation exposure

As part of research and development to protect the public from radiation exposure, we will contribute to the development of a society that is resilient to various radiation accidents by working on the development and practical application of radiation emergency medicine and dosimetry technologies.

Core institutes ▶ Institute for Radiological Science

Related institutes ▶ QST Hospital, Institute for Quantum Life Science, Institute for Quantum Medical Science



Radiation emergency medical research and improvement of national nuclear disaster countermeasures

As the Core Advanced Radiation Emergency Medical Support Center and a designated national public institution, we will work on technical development, technical support, and training of experts in radiation emergency medicine to enhance nuclear disaster medicine.

Dose Assessment Building for Advanced Radiation Emergency Medicine

This is one of the best internal exposure assessment facilities in Japan, capable of comprehensive dose assessment of internal exposure to actinide nuclides and pre-clinical testing of internal decontamination agents. It is also effectively used for research and human resource development for nuclear disaster medicine.

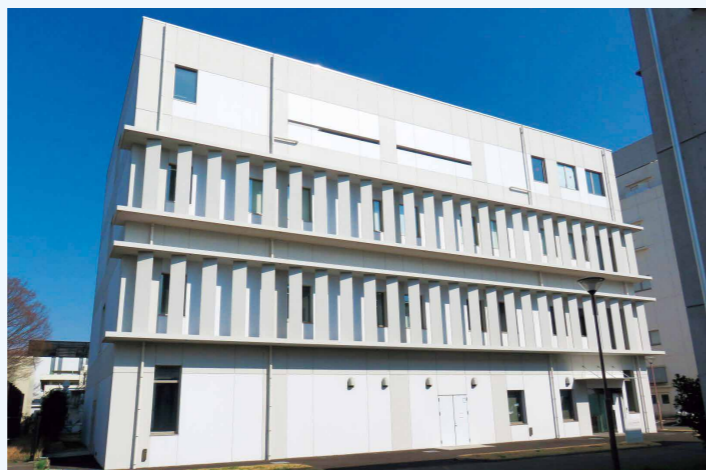

Seminar

Seminars and practical training on the initial response to terrorist incidents involving radiation, chemicals, and explosives are held.

Research on radiation effects and contribution to Fukushima reconstruction assistance

As a technical support organization of the Nuclear Regulation Authority, we will conduct research and development on radiation exposure assessment and radiation health effects based on Japan's experience with the accident at TEPCO Fukushima Daiichi NPS and other incidents, and contribute to support the reconstruction of Fukushima while maintaining an international presence through collaboration with related organizations.



Low Dose Radiation Effects Research Building



Environmental Radiation Research Building

Space radiation measurement and dosimetry



Research for the dynamics of radioactive materials in the environment



Research for biomarkers of radiation-induced carcinogenesis and human risk assessment



Medical radiation evaluation Research



Radiation regulation Research linking science and society



REMAT vehicle



Integrated in-vivo counter system (lung monitor)



Biosimetry research

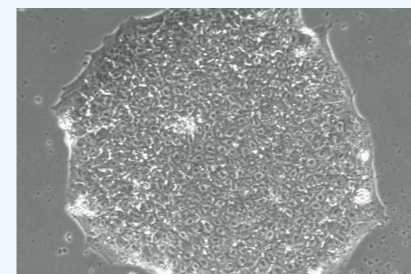

Basic research for application of regenerative medicine to radiation emergency medicine

We have the Radiation Emergency Medical Assistance Team (REMAT), which provides initial medical support on site in the event of radiation exposure or radioactive contamination accidents. REMAT consists of physicians specializing in radiation emergency medicine and experts in radiation protection and dosimetry. In addition, we conduct bioassays for diagnosis and treatment of exposed patients, biological dosimetry, development of techniques for trace analysis of nuclides in environmental samples, and basic research for application of regenerative medicine.

Mission

Realization of fusion energy to support Green Transformation (GX)

We will promote comprehensive research and development, including the construction of the experimental reactor ITER in France and the start of operation of the tokamak-type superconducting plasma experimental system JT-60SA at the Naka Fusion Institute prior to the construction of ITER, with the three major themes: "Promotion of the ITER Project" to demonstrate the scientific and technological feasibility of fusion energy through international cooperation, "Advanced Plasma Research and Development" to study the continuous burning of fuel in a reactor, and "Research and Development of Nuclear Fusion Science and Technology" to support the realization of high-performance plasma.

Core institutes ▶ Naka Fusion Institute, Rokkasho Fusion Institute

Related institutes ▶ Takasaki Institute for Advanced Quantum Science

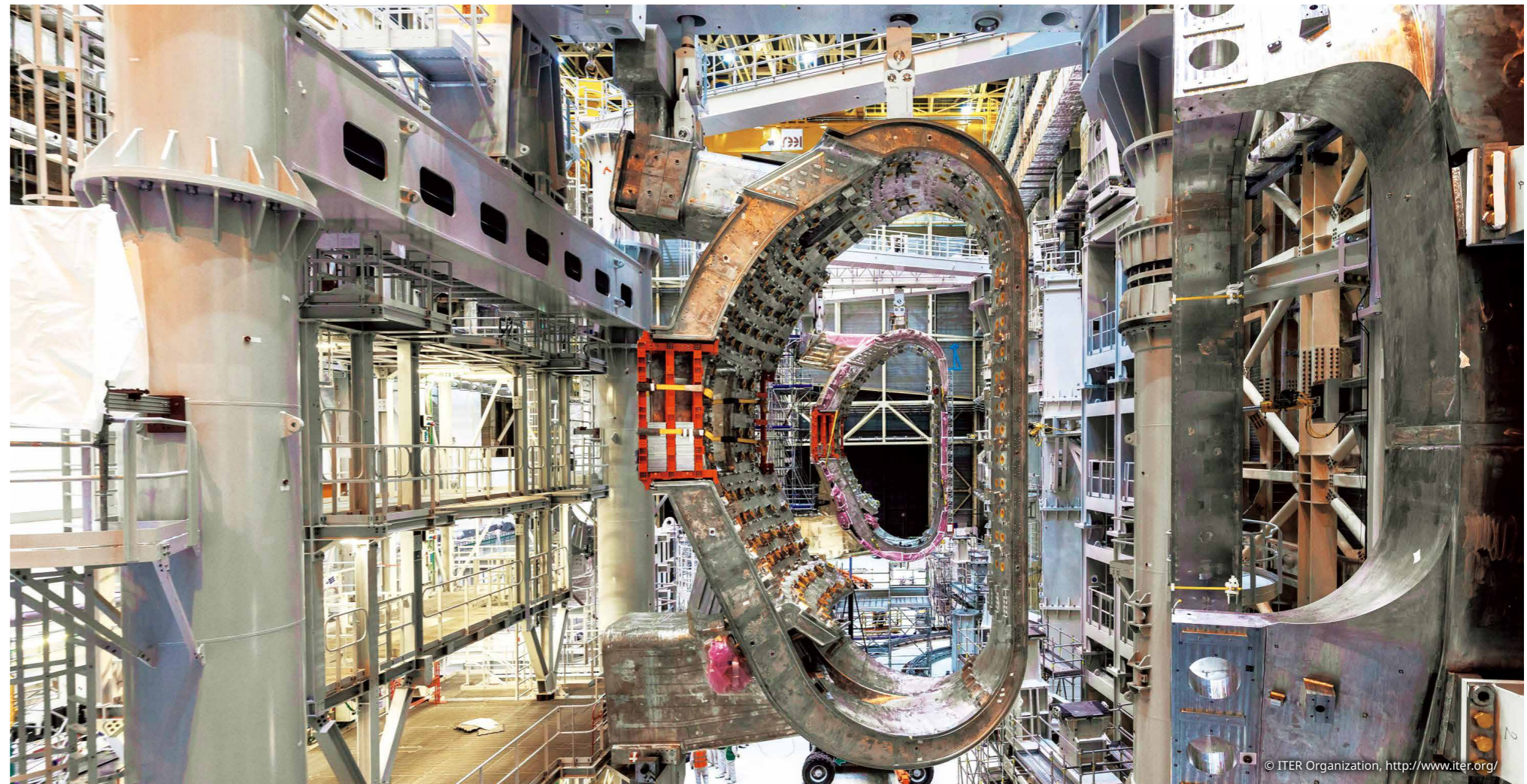

Creating a Sun on Earth!

International Mega-Science project aiming to realize the first experimental fusion reactor for mankind **ITER project**

To realize fusion energy, which is expected to be a fundamental solution to energy and environmental problems, the construction of ITER is underway, bringing together the wisdom of the world's most advanced research programs from the seven regions: Japan, Europe, USA, Russia, South Korea, China, and India. The goal of ITER is to achieve high-power, long-duration combustion using real fuels, deuterium and tritium. Various reactor engineering technologies, such as superconducting coils, are demonstrated for this purpose. QST is designated as ITER Japan Domestic Agency for the activities under the ITER agreement. We will promote procurement activities for ITER equipment and facilities to be shared by Japan and serve as a window for providing human resources to the ITER organization.

Pathway to fusion energy realization

The roadmap to the DEMO reactor first involves demonstrating fusion energy in ITER, which is under construction, followed by demonstrating power generation from fusion energy in the DEMO reactor. What ITER cannot do for the DEMO reactor will be carried out through Broader Approach (BA) activities.

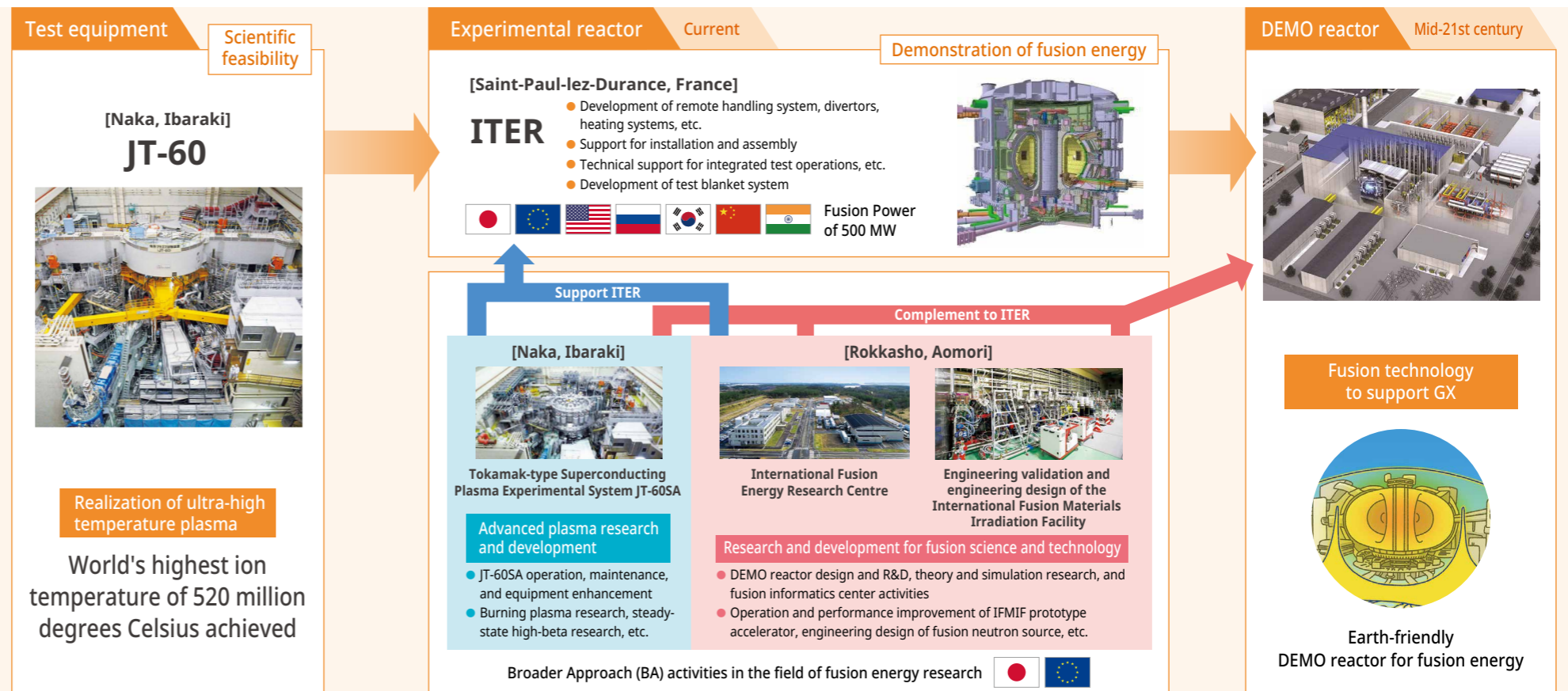

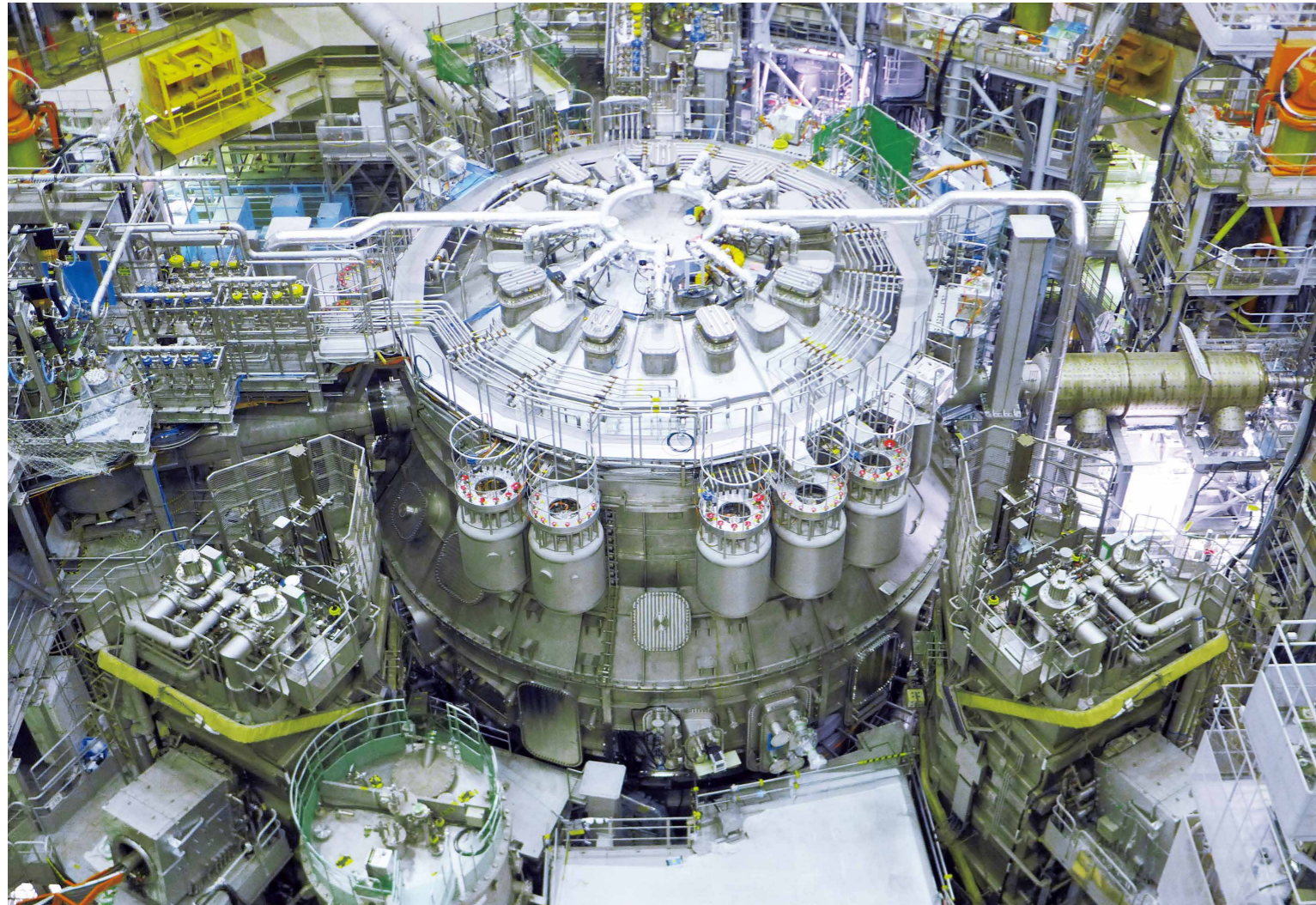

Tokamak-type Superconducting Plasma Experimental System JT-60SA

Constructed at the Naka Fusion Institute as a joint project of the satellite tokamak project, which is being implemented jointly by Japan and Europe, and the national centralized tokamak facility project, which has been studied in Japan, in order to realize fusion energy at an early date. It is the world's largest tokamak-type superconducting plasma experimental system at this time. It is approximately 16 meters high and weighs 2,600 tons.

Purpose of JT-60SA

Support research to achieve ITER's technical goals

Plasma operation with high performance in the same shape as ITER is performed to reflect the results to ITER.

Supplement ITER toward DEMO reactor

For realization of a high power fusion reactor, we aim to establish an operation method to sustain high pressure plasma for sustainment time (about 100 seconds).

Human resource development

We train researchers and engineers who can lead fusion research and development, including the ITER project.

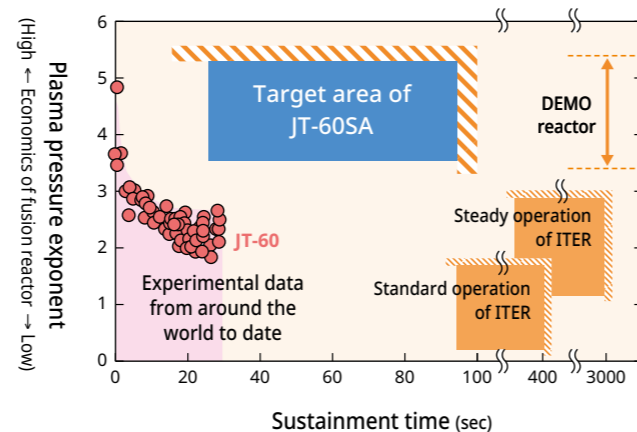

International Fusion Materials Irradiation Facility (IFMIF) prototype accelerator; LIPAc

Prototype accelerator for the IFMIF, an accelerator-driven neutron source, to evaluate the integrity of reactor materials against the 14 MeV⁺ high-energy neutrons generated in a fusion reactor. It is installed and tested at the Rokkasho Fusion Institute through a Broader Approach (BA) activities for the early realization of fusion energy. As an international cooperation, Japan and European countries (Italy, Spain, France, and Belgium) cooperate in the

design and production, and bring them to the Rokkasho Fusion Institute for assembly and testing. Total length is 36 m. The first beam was extracted from the injector in 2014 and the first beam acceleration test was conducted in the RF quadrupole accelerator in 2018. The superconducting linear accelerator is being upgraded to achieve the project's goal of 9 MeV/125 mA²/continuous operation in the integrated beam test using deuterons.

*1 MeV: mega electron-volt, *2 mA: milliampere



IFMIF/EVEDA projects

In an international collaboration between Japan and Europe, we are performing the engineering design of the International Fusion Materials Irradiation Facility (IFMIF, consisting of two accelerators with deuteron beam energy of 40 MeV and beam current of 125 mA), and developing underlying technologies for the devices.

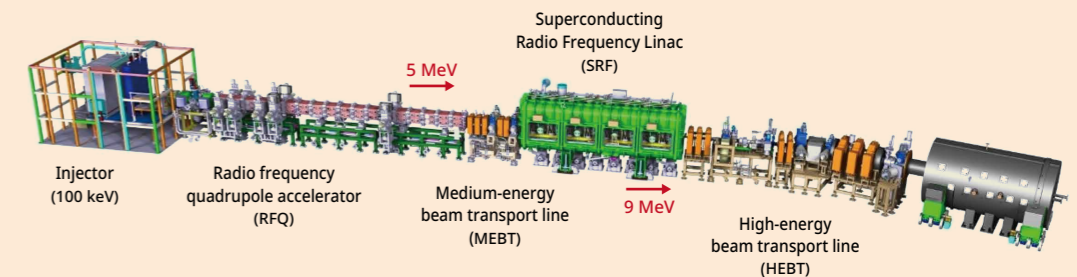

Research and development for DEMO reactor

International fusion energy research centre (IFERC)

- DEMO design studies are being conducted in Japan and Europe at the DEMO Design and R&D Coordination Center to examine common issues for fusion DEMO reactors. R&D items on physical and engineering issues necessary for early realization of the DEMO reactor have been identified to carry out R&D activities.
- The ITER Remote Experimentation Center (REC) is building an IT-based REC in Japan and Europe to enable Japanese domestic

researchers to participate in experimental and analytical research using ITER. In a demonstration test of ultra-high speed transfer technology, we succeeded in transferring 1 TB of data every 30 minutes, or 105 TB of data in 50 hours. In order to utilize the transferred ITER data for the construction of a fusion DEMO reactor, research and development of machine learning and AI techniques in cooperation with the Computational Simulation Center is also underway.



Development of energy-extracting blankets

In the DEMO reactor, a device called a blanket is installed around the core plasma to extract the heat generated by the fusion neutrons and transfer it to the generator. The blanket also serves to protect external equipment from

neutrons and to use neutrons to produce tritium, the fuel for fusion. We are preparing to bring a Test Blanket Module (TBM) to ITER for demonstration testing.

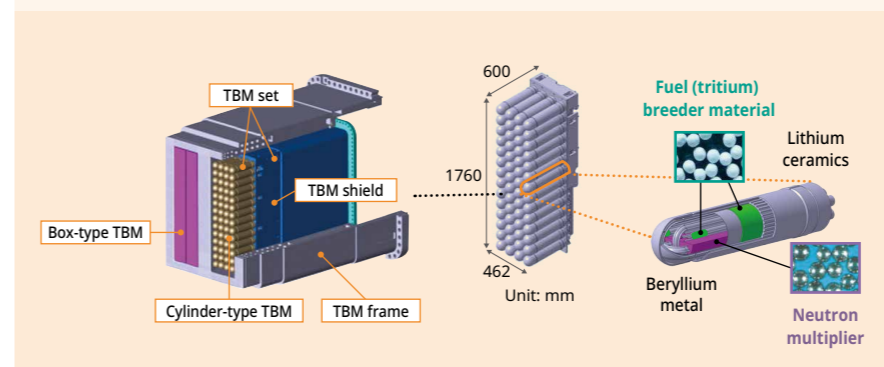

Computational Simulation Centre (CSC)

Using a supercomputer dedicated to fusion research, simulation studies to support the ITER project, DEMO reactor development, and other BA projects are being conducted in Japan and Europe.



Mission

Creation and provision of new value through the use of a large group of research and development facilities

We promote the development and advancement of technologies for generating, controlling, and utilizing quantum beams such as ion beams, electron beams, lasers, and hard and soft X-ray synchrotron radiation, and promote the use of our unparalleled high-performance quantum beam facilities for researchers and engineers in Japan and overseas, as well as their utilization through joint research. Through these efforts, we will promote leading research and development in a wide range of fields, including engineering, biotechnology, and medical science, and create new collaborative activities. The 3 GeV Synchrotron Radiation Facility, NanoTerasu, will be maintained and operated in cooperation and collaboration with regional partners based on a public-private regional partnership, and will be shared in accordance with the Act on the Promotion of Public Utilization of the Specific Advanced Large Research Facilities.

Core institutes ▶ Institute for Advanced Synchrotron Light Source, Takasaki Institute for Advanced Quantum Science, Kansai Institute for Photon Science, Institute for Quantum Medical Science

Related institutes ▶ QST Hospital, Institute for Quantum Life Science, Institute for Radiological Science, Naka Fusion Institute, Rokkasho Fusion Institute



It is scheduled to start operation in FY2024. By utilizing synchrotron radiation (X-rays), it will produce a variety of measurement data that will contribute to cutting-edge academic research, industrial applications, and solutions to social issues in various fields, such as quantum devices, clean energy, biotechnology, and food production. Compared to similar synchrotron radiation facilities around the world, this facility has the world's top-level light source performance in a compact design.

Institute for Advanced Synchrotron Light Source

3 GeV Synchrotron Radiation Facility, NanoTerasu

Development and shared-use promotion of the 3 GeV Synchrotron Radiation Facility

The 3 GeV Synchrotron Radiation Facility, which is expected to be in high demand for both academic and industrial use and will contribute to strengthening research capabilities and improving productivity in Japan's industry, academia, and government, will be a leading case of a state-of-the-art large-scale research facility based on public-private regional partnerships.

[National Entity]

National Research and Development Agency; National Institutes for Quantum Science and Technology

[Partners]

General Incorporated Foundations
Photon Science Innovation Center (PhoSIC), Miyagi Prefecture, Sendai City, National University Corporation Tohoku University, General Incorporated Association Tohoku Economic Federation

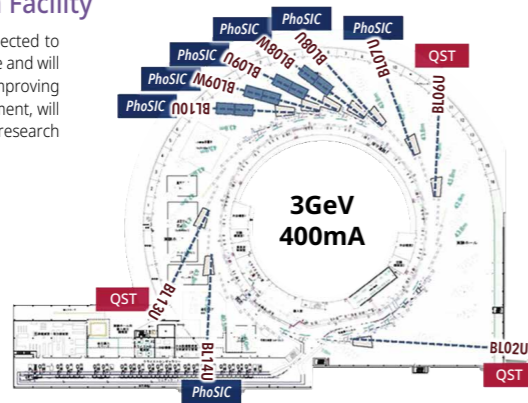

National
3 beamlines
Leading natural science with the world's highest performance
BL-02U: Resonant Inelastic X-ray Scattering (RIXS)
BL-06U: Angle-Resolved Photoemission Spectroscopy (ARPES)
BL-13U: Soft X-ray Magnetic Circular Dichroism

Coalition
7 beamlines
Visualizing various material functions
BL-07U: Soft X-ray Electronic Structure Analysis
BL-08U: Soft X-ray Operando Spectroscopy
BL-08W: Integrated Analysis of Chemical State and Nano/Local Structure
BL-09U: X-ray Operando Spectroscopy
BL-09W: X-ray Multiscale Structure Analysis
BL-10U: X-ray Coherent Imaging
BL-14U: Soft X-ray Imaging

Takasaki Institute for Advanced Quantum Science



Ion Irradiation Research Facility TIARA

Four types of ion accelerators (AVF cyclotron, tandem accelerator, single-ended accelerator, and ion implanter) provide a range of ion types and energies for diverse research and development from creation of quantum materials, environment materials and energy materials to RI production and ion beam breeding. It is also used as an ion beam irradiation facility, which is important for establishing fundamental technologies such as single-photon source formation for quantum sensing and quantum computing.

Electron-beam Irradiation Facility

Capable of electron irradiation over a wide dose range from low to high doses (several kGy to MGy). The facility is used for research into the creation of quantum materials and is the center of fundamental quantum technology for the creation of solid-state quantum sensors and the creation of quantum bits (NV centers) for the development of elemental devices.

Cobalt 60 Gamma-ray Irradiation Facilities

The facility covers a wide dose rate range from radiation resistance tests requiring high dose rates for environmental and energy material development and radiation resistance tests for space, nuclear reactor and fusion reactor materials to low dose rates required for biological mutation breeding research, and has six irradiation chambers capable of permanent and long-term irradiation of large irradiation vessels.

Kansai Institute for Photon Science (Kizu)

Ultra-high Intensity Laser Experimental system (J-KAREN-P)

This is the highest-power ultra-short pulse (femtosecond) petawatt laser system in Japan, which enables irradiation experiments at the world's top level of focused laser intensity. Used for research on laser-driven ion acceleration, development of quantum beam sources such as high-brilliant and high-energy X-ray generation, and high-intensity field science research through international joint experiments to elucidate high-energy astrophysics.

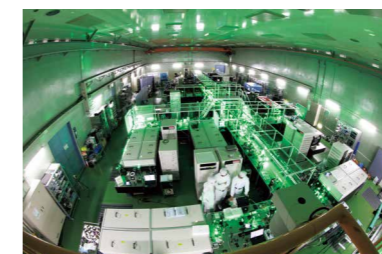

Laser experimental system (QUADRA-T)

The world's most advanced 100W-class picosecond laser pumped ultra-short infrared pulse light source with high repetition rate and high average power. Ultra-fast measurements using ultra-short pulsed lasers and attosecond soft X-ray sources are expected to be applied to the creation and control of quantum materials and quantum life science.



Kansai Institute for Photon Science (Harima)

QST Contract Beamlines at large synchrotron radiation facility SPring-8

This is a group of advanced measurement devices for nondestructive operando nanostructure observation and precise magnetic and electronic state analysis using hard X-rays of high-brilliant synchrotron radiation. Research on quantum materials and environmental energy materials (hydrogen storage materials) by realizing magnetic measurement of individual atomic layers using advanced analysis technology with synchrotron radiation is being promoted.



Quantum beam facilities open to the public inside and outside QST

Institute for Quantum Medical Science

Heavy-ion cancer radiotherapy facility

The Heavy-Ion Medical Accelerator for Cancer Therapy (HIMAC) at the Institute for Quantum Medical Science supports heavy-ion cancer radiotherapy and clinical research, and provides high-energy heavy-ion beams of various nuclei to universities, research institutes, and private users in Japan and abroad.



Cyclotron accelerator facility

Cyclotron accelerator facility is the foundation for the development and production of radiopharmaceuticals. It contributes to cutting-edge research and development at research institutes, universities, and private companies in Japan and overseas.

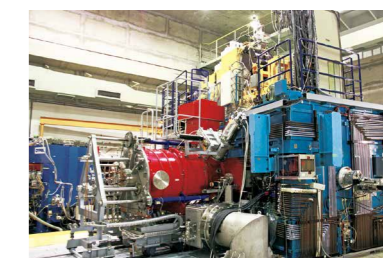

Two innovation hub projects are underway

Alliance project

The project's goal is to create innovation by forming alliances with private companies centered on QST's cutting-edge technologies, solving common technological issues that exist in industry through collaboration with multiple companies, solving issues for individual companies, and conducting step-by-step research and development.

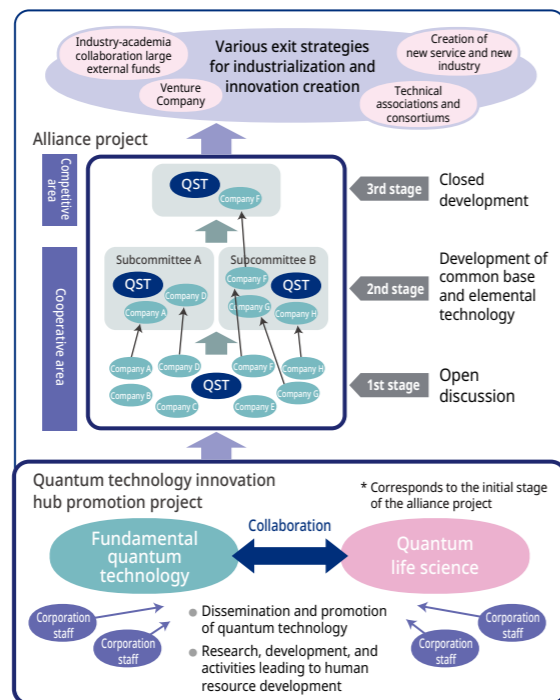

Quantum technology innovation hub promotion project

The Foundational Quantum Technology Hub and Quantum Life R&D Hub, which have been recognized as national Quantum Technology Innovation Hubs, are promoting the integration of quantum technology and life science and the social implementation of quantum technology with highly functional and high-performance quantum materials at its core, and are supporting these activities. In addition, we focus on human resource development in industry and activities to promote the spread of quantum technology in order to raise awareness of quantum technology in companies and promote its practical application, aiming to realize social implementation of quantum technology as soon as possible.

Activities to return QST's research results to society

Industry-academia collaboration

QST conducts comprehensive research and development on quantum science and technology, while collaborating with domestic and international research institutes, universities, and industries, and exchanging human resources, as well as conducting activities to return the results of such research and development to society.

Researcher hosting program (human resource exchange)

For promotion of efficient and effective research and development, QST has established a system for receiving guidance and advice from researchers with advanced expertise and outstanding achievements from Japan and overseas, and a system for accepting researchers from universities and companies to cooperate in QST's research and development projects.

QST certified venture support system

QST supports the establishment of venture companies that utilize the results of QST's research and development in order to promote the establishment of social return and positive cycle through the dissemination of research and development results by the venture companies and through their practical application in industry.

QST is promoting the SIP 3rd phase project

"Promoting the Application of Advanced Quantum Technology Platforms to Social Issues".



The 3rd Phase of Cross-ministerial Strategic Innovation Promotion Program (SIP)

The SIP is a national project that promotes research and development from basic research to social implementation in a comprehensive manner. The 3rd phase of the SIP has newly started in FY2023, and QST is in charge of the research promotion corporation for one of its topics, "Promoting the Application of Advanced Quantum Technology Platforms to Social Issues".

This topic aims to accelerate progress toward Society 5.0 through cutting-edge research and development in the fields of (i) quantum computing, (ii) quantum security networks, (iii) quantum sensing, and (iv) innovation creation foundations, as well as their social implementation. The role of QST in this program is to manage the progress of the research and development themes, conduct technical and project evaluations from a professional perspective, and perform management tasks, including public solicitation and contracting. Through these tasks, we will promote the use of quantum technology, expand the range of users, and contribute to the social implementation and practical use of quantum technology in Japan.

QST's diversity

QST is promoting efforts to realize a diversity oriented environment in which employees with diverse ideas and experiences, regardless of nationality, gender, age, or disability, can work independently and continuously produce excellent research results. On July 14, 2021, we achieved the numerical targets in the General Employer Action Plan based on the Act on Advancement of Measures to Support Raising Next-Generation Children, and received the "Kurumin Mark" certification from the Minister of Health, Labour and Welfare as a "Company Supporting Child-Raising." We will continue to work on the action plan to go even further.



KOYASU Shigeo, President, holding the "Iku-Boss Declaration"; on the right, HOSHINO Toshihiko, Executive Director; and on the left, TAKEDA Shino, Director of the Diversity Promotion Office. "Iku-Boss" stands for a parenting-supportive boss.

Support system

Research support

- Grant program for research supporting staff
- Support program for inviting foreign researchers to Japan



Childcare and nursing care support

- Discount coupons for childcare and partial subsidies for babysitting fees



Nursing

- Signed agreements with corporate-led nursery facilities



Seminars and social events

Various seminars and social events are held every year to improve the skills of staff and enhance their work/life balance.

- Work/life balance seminar
- Research skill improvement seminar
- Nursing care seminar
- LGBTQ seminar
- Online lunch social event
- Social event for staff with childcare responsibilities



Publication

Booklet for childcare/caregiver support

It provides useful information on childcare/caregiving, including information on various procedures and support systems.



QST diversity news "Harmony"

A booklet full of useful information is published once a year, including reports on the activities of the Diversity Promotion Office, introductions of support systems, comments from users of support systems, columns by employees raising children, and other information.

Initiatives to promote a diversity oriented environment

With the aim of promoting initiatives suited to the circumstances of each institute, the Diversity Promotion Office has been calling for proposals for original initiatives to promote a diversity environment since 2021, and for those adopted, the Diversity Promotion Office subsidizes a portion of the expenses and awards prizes to highly evaluated initiatives.

Issued by

National Institutes for Quantum Science and Technology
Public Relations Section, Department of Management and Planning

Issued on November 1, 2023.

Edited by

QST Pamphlet Production Team

Supported by

iWAT Co., Ltd.

Success will come where there is hope.



**National Institutes for
Quantum Science and Technology**

Public Relations Section, Department of Management and Planning

4-9-1 Anagawa, Inage-ku, Chiba-shi, Chiba 263-8555
TEL +81-43-206-3026 (direct)
E-mail: info@qst.go.jp
<https://www.qst.go.jp>

